

Service Service Service



Service Manual

TABLE OF CONTENTS

	Chapter
Technical Specification & Service Tips	1
Safety Instructions	2
Instruction for Use	3
Mechanical Instructions	4
Troubleshooting	5
Overall Block Diagram	6
Overall Wiring Diagram	7
Electrical Diagram	8
Component Layout	9
Service Part List	10
Revision List	11

©Copyright 2005 Philips Consumer Electronics B.V. Eindhoven, The Netherlands
 All rights reserved. No part of this publication may be reproduced, stored in a
 retrieval system or transmitted, in any form or by any means, electronics,
 mechanical, photocopying, or otherwise without the prior permission of Philips

1.0 TECHNICAL SPECIFICATION

General

Dimensions (W x H x D): 204 x 168 x 33 mm
 Weight: 1.0kg
 Power supply: DC 9V 1.8A
 Power consumption: 20W
 Operating temp. & RH: 0 - 50 degC / 30 – 90% RH
 Laser wavelength: 650nm
 Video system: NTSC / PAL / AUTO

Dynamic range: >=80dB
 Signal/Noise ratio: >=85dB
 Frequency response: 20Hz-20kHz +/-1dB
 Channel Separation 1kHz: >=85dB
 Channel Balance 1kHz: 1dB

Audio out (analog audio) Output level: 2V +/- 10%
 Load impedance: 10Kohm
 Video out Output level: 1Vp – p +/- 20%
 Load impedance: 75ohm

Current consumption

DC-IN SUPPLY (9V)	
Battery Charging Current	1.2A typical
BATT. SUPPLY (7.2V)	
Power Off	0A
Playback with TFT on	<1.2A typical
Playback without TFT on	<600mA
Battery time (playback)	>4 hours

Headphone out (headphone output load 2x16 ohm)

Maximum output power: >10mW
 Frequency response: 20Hz – 20kHz
 SNR (A-wght): 80dB typical
 THD (0.2-20kHz): <1%
 Left-Right Channel Separation: 32dB
 Left-Right Channel Balance: 1dB

Supported disc type

Video Playback Formats:



Audio Playback Formats:



Playback disc type: DVD, Picture-CD, SVCD, Video CD, MP3-CD, CD-R/CD-RW, WMA-CD, DVD-R, DVD-RW, DVD+R, DVD+RW

Video Playback Format: DVD / VCD / JPEG

Audio Playback Format: CD/MP3, MP3-DVD, WMA

Disc Diameter: 12cm

Pixel specification

Zero bright-dot & max. 3 dark-dots

Factory Service Mode (FSM)

1.0 TECHNICAL SPECIFICATION

Procedure to check the software version of your portable DVD Player

1. Press [SETUP] to enter the setup Menu
2. Press [RETURN] and then press "1" -> "2" -> "3" by remote control
3. The display will show the software version as the date of which the software was built on the bottom of the screen.

Procedure to upgrade the software of your portable DVD Portable

For the best performance of your DVD Portable. Check www.philips.com/support for latest software upgrades available.

1. Download the latest software from the Philips support site
2. Unzip the files and then burn it into a CD-ROM to make a disc for upgrade
3. Power on the Portable DVD Player with AC/DC adaptor
4. Play CD-ROM for firmware upgrade

Warning: Do not unplug the AC adaptor during firmware upgrade to prevent flash corrupt of the set!!

5. Once upgrade is completed, the player is reset automatically
6. Open the DVD door to remove the disc

Procedure to change region code of your portable DVD player

1. Power on player and open the DVD door
2. Press [SETUP] by remote control.
3. In Set Up Menu, select <Audio> and press [OK]
4. Press [2], [1], [2], [2], [2], [5], [<], [v]
5. Display will show the Region Code
6. Press Number Key button by remote control to select the region code
7. Refer below table for your region code setting

Region Code	Region
1	USA
2	EUROPE
3	ASIA PACIFIC
4	AUSTRALIA, NEW ZEALAND, LATAM
5	RUSSIA, INDIA
6	CHINA

Region code "0" can be used for all regions!

8. Press [SETUP] to save and exit your setting
9. Power off and power on again to verify if region code change is done

Remarks:

1. **Password is CONFIDENTIAL**
2. **Region code is printed on product type plate. Due to DVD legislation region codes different to assigned region may not be released**

2.0 SAFETY INSTRUCTIONS

GB WARNING

All ICs and many other semi-conductors are susceptible to electrostatic discharges (ESD). Careless handling during repair can reduce life drastically. When repairing, make sure that you are connected with the same potential as the mass of the set via a wrist wrap with resistance. Keep components and tools also at this potential.

F ATTENTION

Tous les IC et beaucoup d'autres semi-conducteurs sont sensibles aux décharges statiques (ESD). Leur longévité pourrait être considérablement écourtée par le fait qu'aucune précaution n'est prise à leur manipulation. Lors de réparations, s'assurer de bien être relié au même potentiel que la masse de l'appareil et enfilez le bracelet serti d'une résistance de sécurité. Veiller à ce que les composants ainsi que les outils que l'on utilise soient également à ce potentiel.

D WARNUNG

Alle ICs und viele andere Halbleiter sind empfindlich gegenüber elektrostatischen Entladungen (ESD). Unsorgfältige Behandlung im Reparaturfall kann die Lebensdauer drastisch reduzieren. Veranlassen Sie, dass Sie im Reparaturfall über ein Pulsarmband mit Widerstand verbunden sind mit dem gleichen Potential wie die Masse des Gerätes. Bauteile und Hilfsmittel auch auf dieses gleiche Potential halten.

ESD



NL WAARSCHUWING

Alle IC's en vele andere halfgeleiders zijn gevoelig voor electrostatische ontladingen (ESD). Onzorgvuldig behandelen tijdens reparatie kan de levensduur drastisch doen verminderen. Zorg ervoor dat u tijdens reparatie via een polsband met weerstand verbonden bent met hetzelfde potentiaal als de massa van het apparaat. Houd componenten en hulpmiddelen ook op ditzelfde potentiaal.

I AVVERTIMENTO

Tutti IC e parecchi semi-conduttori sono sensibili alle scariche statiche (ESD). La loro longevità potrebbe essere fortemente ridotta in caso di non osservazione della più grande cauzione alla loro manipolazione. Durante le riparazioni occorre quindi essere collegato allo stesso potenziale che quello della massa dell'apparecchio tramite un braccialetto a resistenza. Assicurarsi che i componenti e anche gli utensili con quali si lavora siano anche a questo potenziale.

GB

Safety regulations require that the set be restored to its original condition and that parts which are identical with those specified, be used.

"Pour votre sécurité, ces documents doivent être utilisés par des spécialistes agréés, seuls habilités à réparer votre appareil en panne".

NL

Veiligheidsbepalingen vereisen, dat het apparaat bij reparatie in zijn oorspronkelijke toestand wordt teruggebracht en dat onderdelen, identiek aan de gespecificeerde, worden toegepast.

F

Les normes de sécurité exigent que l'appareil soit remis à l'état d'origine et que soient utilisés les pièces de rechange identiques à celles spécifiées.

D

Bei jeder Reparatur sind die geltenden Sicherheitsvorschriften zu beachten. Der Originalzustand des Geräts darf nicht verändert werden; für Reparaturen sind Original-Ersatzteile zu verwenden.

I

Le norme di sicurezza esigono che l'apparecchio venga rimesso nelle condizioni originali e che siano utilizzati i pezzi di ricambio identici a quelli specificati.

"After servicing and before returning set to customer perform a leakage current measurement test from all exposed metal parts to earth ground to assure no shock hazard exist. The leakage current must not exceed 0.5mA."



GB Warning !

Invisible laser radiation when open. Avoid direct exposure to beam.

S Varning !

Osynlig laserstrålning när apparaten är öppnad och spärrar är urkopplad. Betrakta ej strålen.

SF Varoitus !

Avatussa laitteessa ja suojalukituksen ohitettaessa olet alltiina näkymättömälle laserisäteilylle. Älä katso säteeseen!

DK Advarsel !

Usynlig laserstråling ved åbning når sikkerhedsafbrydere er ude af funktion. Undgå udsættelse for stråling.

2.1 ESD PROTECTION

- レンズには絶対に触れないでください。
- DO NOT TOUCH THE LENS.
- LINSE NICHT BRÜHREN.
- NE PAS TOUCHER LA LENTILLE.

When the power supply is being turned on, you may not remove this laser cautions label. If it removes, radiation of laser may be received.

PREPARATION OF SERVICING

Pickup Head consists of a laser diode that is very susceptible to external static electricity.

Although it operates properly after replacement, if it was subject to electrostatic discharge during replacement, its life might be shortened. When replacing, use a conductive mat, soldering iron with ground wire, etc. to protect the laser diode from damage by static electricity.

And also, the LSI and IC are same as above.

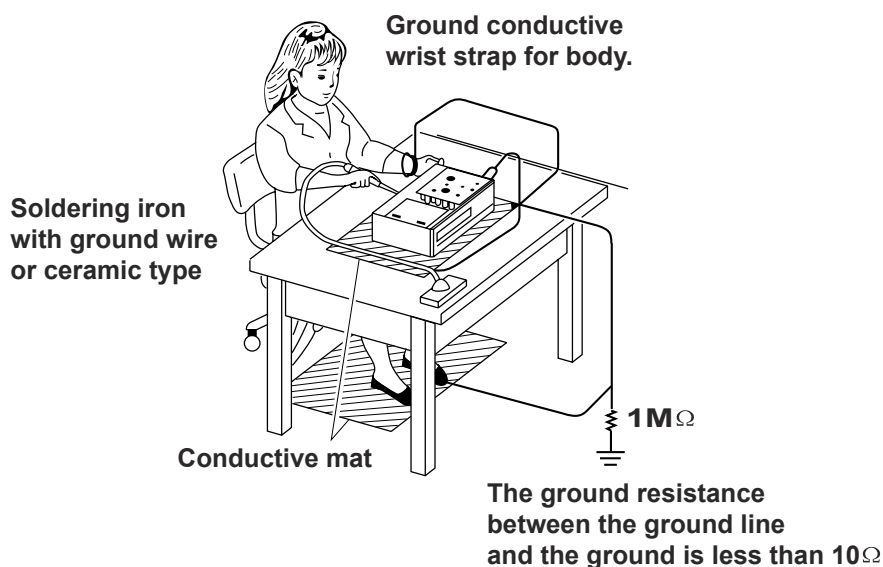

SAFTY NOTICE

SAFTY PRECAUTIONS

LEAKAGE CURRENT CHECK

Plug the AC line cord directly into a 120V AC outlet (do not use an isolation transformer for this check). Use an AC voltmeter, having 5000Ω per volt or more sensitivity. Connect a 1500Ω 10W resistor, paralleled by a $0.15\mu\text{F}$ 150V AC capacitor between a known good earth ground (water pipe, conduit, etc.) and all exposed metal parts of cabinet (antennas, handle bracket, metal cabinet screwheads, metal overlays, control shafts, etc.).

Measure the AC voltage across the 1500Ω resistor. The test must be conducted with the AC switch on and then repeated with the AC switch off. The AC voltage indicated by the meter may not exceed 0.3V. A reading exceeding 0.3V indicates that a dangerous potential exists, the fault must be located and corrected. Repeat the above test with the DVD VIDEO PLAYER power plug reversed. NEVER RETURN A DVD VIDEO PLAYER TO THE CUSTOMER WITHOUT TAKING NECESSARY CORRECTIVE ACTION.

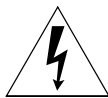
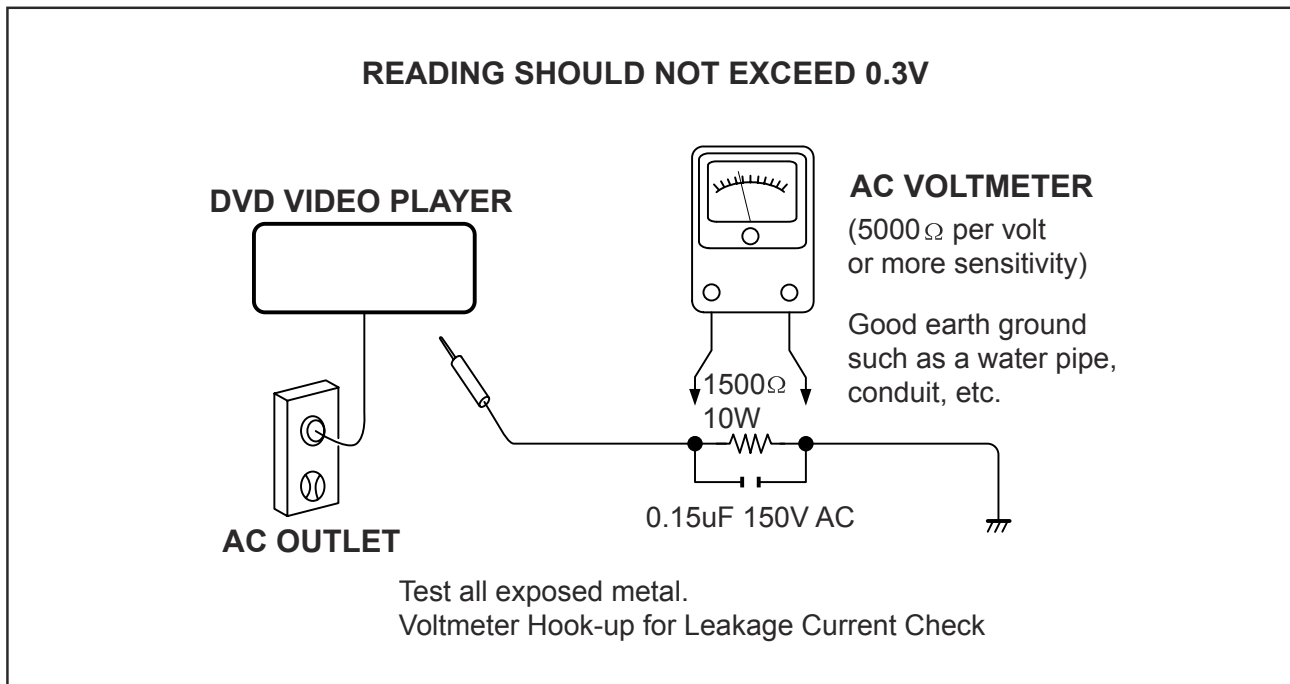

The lightning flash with arrowhead symbol, within an equilateral triangle, is intended to alert the user to the presence of uninsulated "dangerous voltage" within the product's enclosure that may be of sufficient magnitude to constitute a risk of electric shock to persons.



The exclamation point within an equilateral triangle is intended to alert the user to the presence of important operating and maintenance (servicing) instructions in the literature accompanying the appliance.

3.0 INSTRUCTIONS FOR USE

- | | |
|-----------------------------------------------------------------------------------------------------------------|--------------------------------------------------------------------|
| ① ▶
Start / pause / resume playback. | ⑫ POWER
Switches the player on / off. |
| ② ■
Press once to stop playback and store the stop position. Press twice to stop playback completely. | ⑬ CHR/IR/POWER
Power /remote sensor /charging indicator. |
| ③ ◀◀ / ▶▶
Search backward (◀◀) or search forward (▶▶). | ⑭ RESET
Reset the player when it is hanged up. |
| ④ - VOL +
Volume control. | ⑮ Car mounting screw hole |
| ⑤ SETUP
Enter SETUP menu. | ⑯ Headphones jack. |
| ⑥ DISPLAY
Adjust the display value of the system. | ⑰ AV OUT
Audio/video output jack. |
| ⑦ DISC MENU
Display MUNE page. | ⑱ AV IN
Audio/video input jack. |
| ⑧ ▲, ▼, ◀, ▶
Up / down / left / right cursor.
OK
Confirm seletion. | ⑲ USB
USB connector. |
| ⑨ OPTION
Access additional functions. | ⑳ SD•MMC•MS CARD
Insert SD/MMC CARD. |
| ⑩ CHR/IR/POWER
Power /remote sensor /charging indicator. | ㉑ COAXIAL
Digital Audio output jack. |
| ⑪ OPEN
Opens disc door to insert or remove disc. | ㉒ COMP.OUT/S VIDEO
Component / S video output. |
| | ㉓ DC IN 9V
Power supply socket. |

CAUTION

Use of controls or adjustments or performance of procedures other than herein may result in hazardous radiation exposure or other unsafe operation.

DVD PLAYER LAYOUT

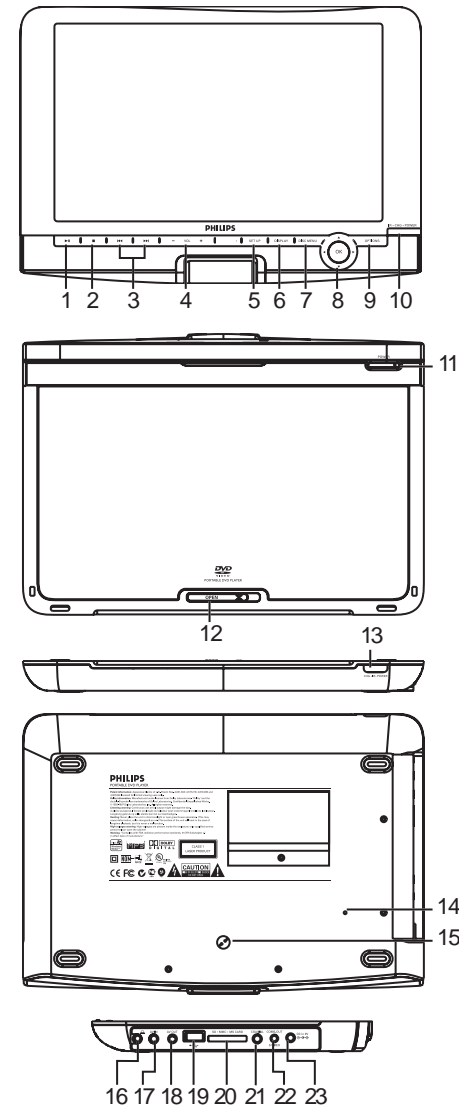

REMOTE CONTROL

- ① **MENU**
Display **MENU** page.
- ② ▲, ▼, ◀, ▶
Up / down / left / right navigation key.
- OK**
Confirm selection.
- VOL +/-**
Volume control.
- ③ **DISPLAY**
Adjust the display value of the system.
- ④ ⏮
Skip to previous chapter, track or title.
- ⑤ ▶⏸
Start / pause / resume playback
- ⑥ ■
Access additional functions.
- ⑦ **0 - 9**
Numeric keypad.
- ⑧ **SUBTITLE**
Subtitle language selector.
- ⑨ **RETURN**
For VCD menu page.
- ⑩ **A - B**
To repeat or loop a sequence in a title.
- ⑪ **SETUP**
Enter **SETUP** menu.
- ⑫ **OPTION**
Access additional functions.
- ⑬ ▶▶
Skip to next chapter, track or title.
- ⑭ 🔇
Mute player volume
- ⑮ **AUDIO**
Audio language selector.
- ⑯ **ZOOM**
Enlarge video image.

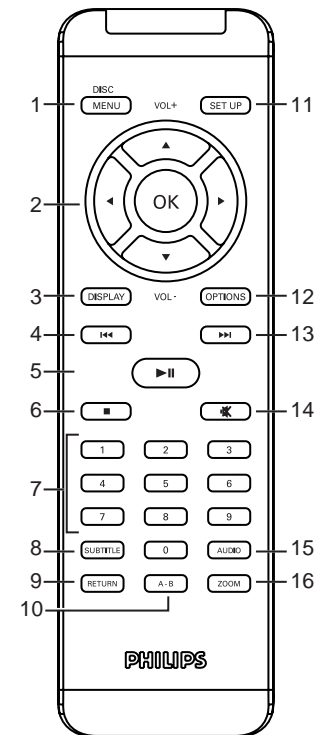

4.0 MECHNICAL INSTRUCTIONS

1. Side view as Fig.1

Remove base cover adorn discreteness as Fig.1.



Fig.1

2. Remove screws of the base cover as Fig.2.

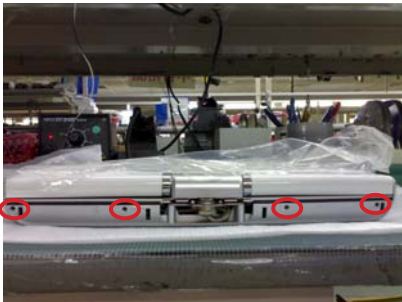

Fig.2

3. Remove screws of the base cover as Fig.3



Fig.3

4. Open the door and remove screws to remove door & middle cabinet discreteness as Fig.4.



Fig.4

5. Rotate the top and remove screws to break the top and the base away as Fig.5.



Fig.5

6. Broken connection of DVD driver to remove DVD driver as Fig.6.

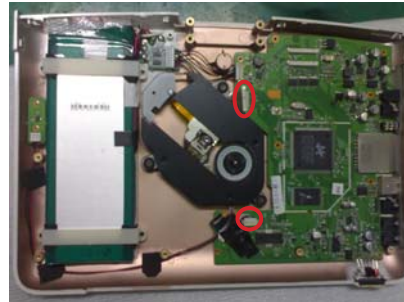

Fig.6

7. Remove screws to remove lithium battery and lithium battery protective pcb as Fig.7.

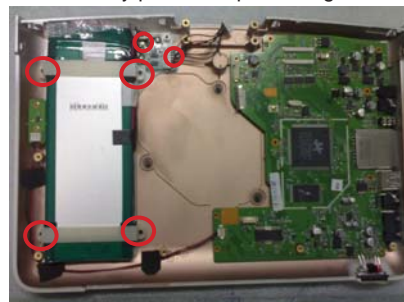

Fig.7

8. Remove screws to remove main board as Fig.8.

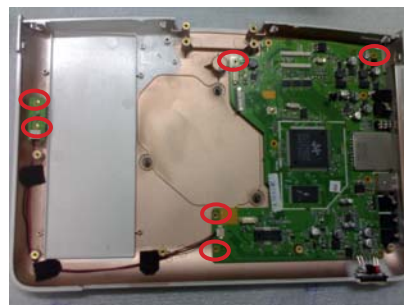

Fig.8

4.0 MECHNICAL INSTRUCTIONS

9. Remove speaker grill as Fig.9.



Fig.9

10. Remove screws to remove top cover discreteness as Fig.10.



Fig.10

11. Remove screws and broken connection to remove IF board and LED driver board as Fig.11.

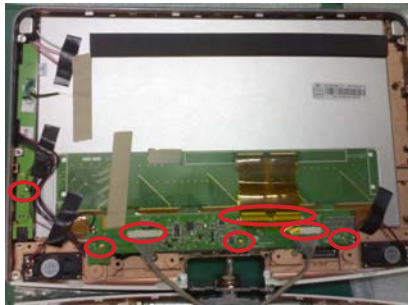

Fig.11

12. Remove LCD TFT and function board as Fig.12.

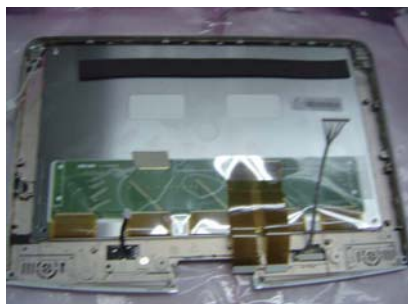
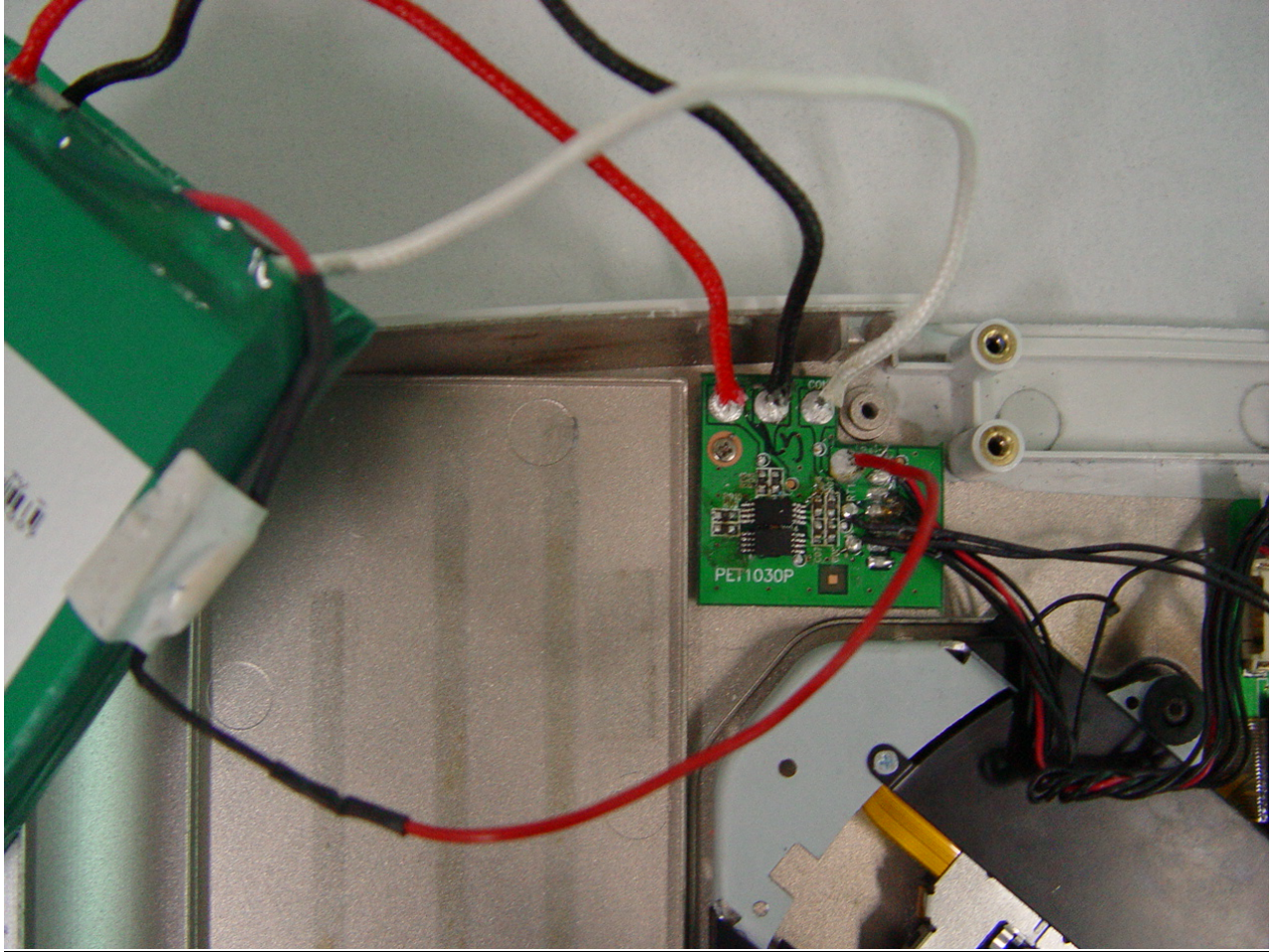

Fig.12

4.0 MECHANICAL INSTRUCTIONS

Close up on the connectivity of 996510006526 & 996510003961



5.0 TROUBLESHOOTING & SERVICE TIPS

Procedure to change regioncode

1. Power on player and open DVD Door.
2. Press <Set Up> at Remote Control. In <Set Up Menu> select <Preferences>.
3. For PET1031 - Press successively 2 1 2 2 2 5. ◀. ▼.
4. Display will show <Region Code 2> for Europe:
5. Press key to input preference region code (see below table).
6. Switch off and re-switch on the product.
7. Verify Region code change done.

Region Code	Region
1	USA
2	EUROPE
3	ASIA PACIFIC
4	AUSTRALIA, NEW ZEALAND, LATAM
5	RUSSIA, INDIA
6	CHINA

REMARKS:

1. Password is CONFIDENTIAL.
2. Region code is printed on product type plate. Due to DVD legislation region codes different to assigned region may not be released.

5.0 TROUBLESHOOTING & SERVICE TIPS

SYMPTOM: NO POWER, NO GREEN LED

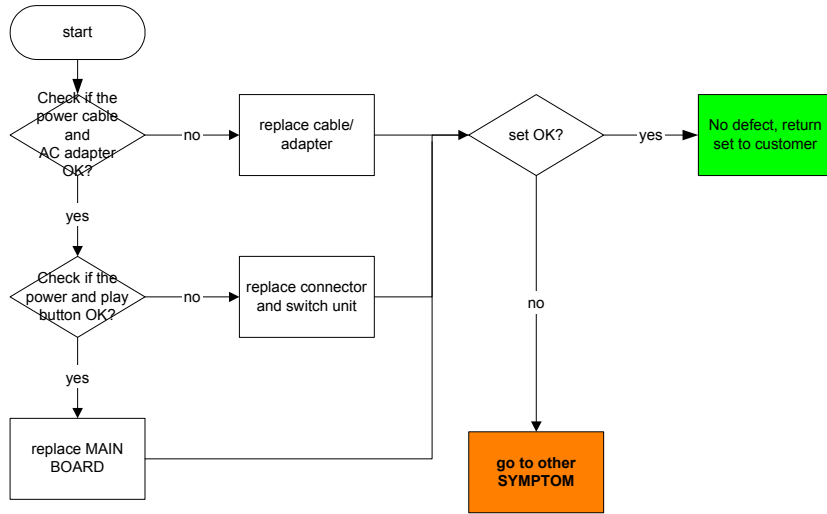

SYMPTOM: NO IMAGE OR SOUND COMES OUT FROM THE EXTERNAL OUTPUT

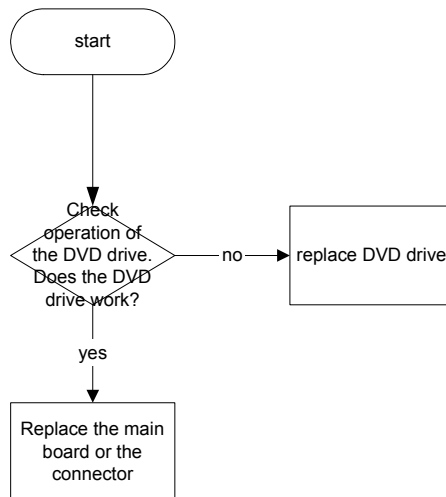

5.0 TROUBLESHOOTING & SERVICE TIPS

SYMPTOM: THE INITIAL SCREEN IS NOT DISPLAYED ON THE LCD

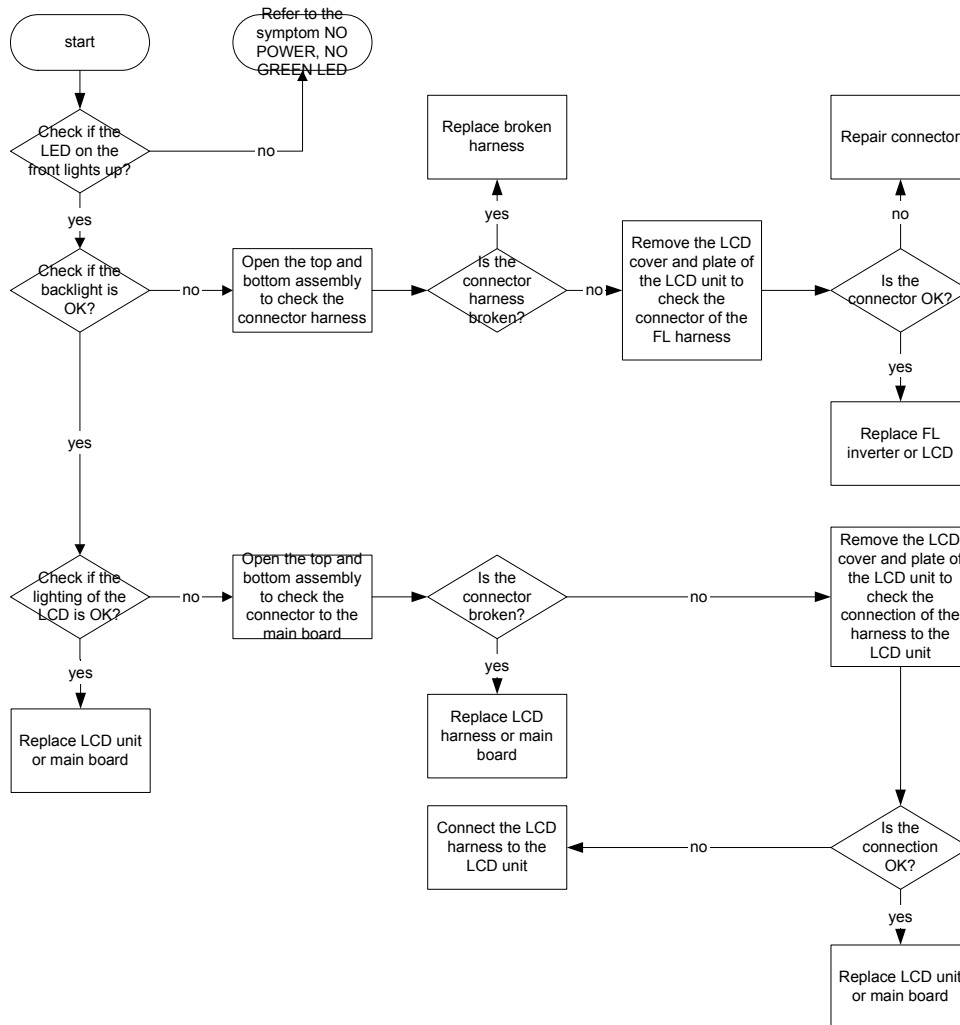

SYMPTOM: NO IMAGE OR SOUND COMES OUT FROM THE EXTERNAL INPUT

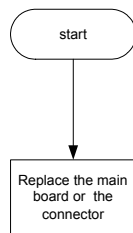

5.0 TROUBLESHOOTING & SERVICE TIPS

SYMPTOM: THE DVD DRIVE DOES NOT WORK

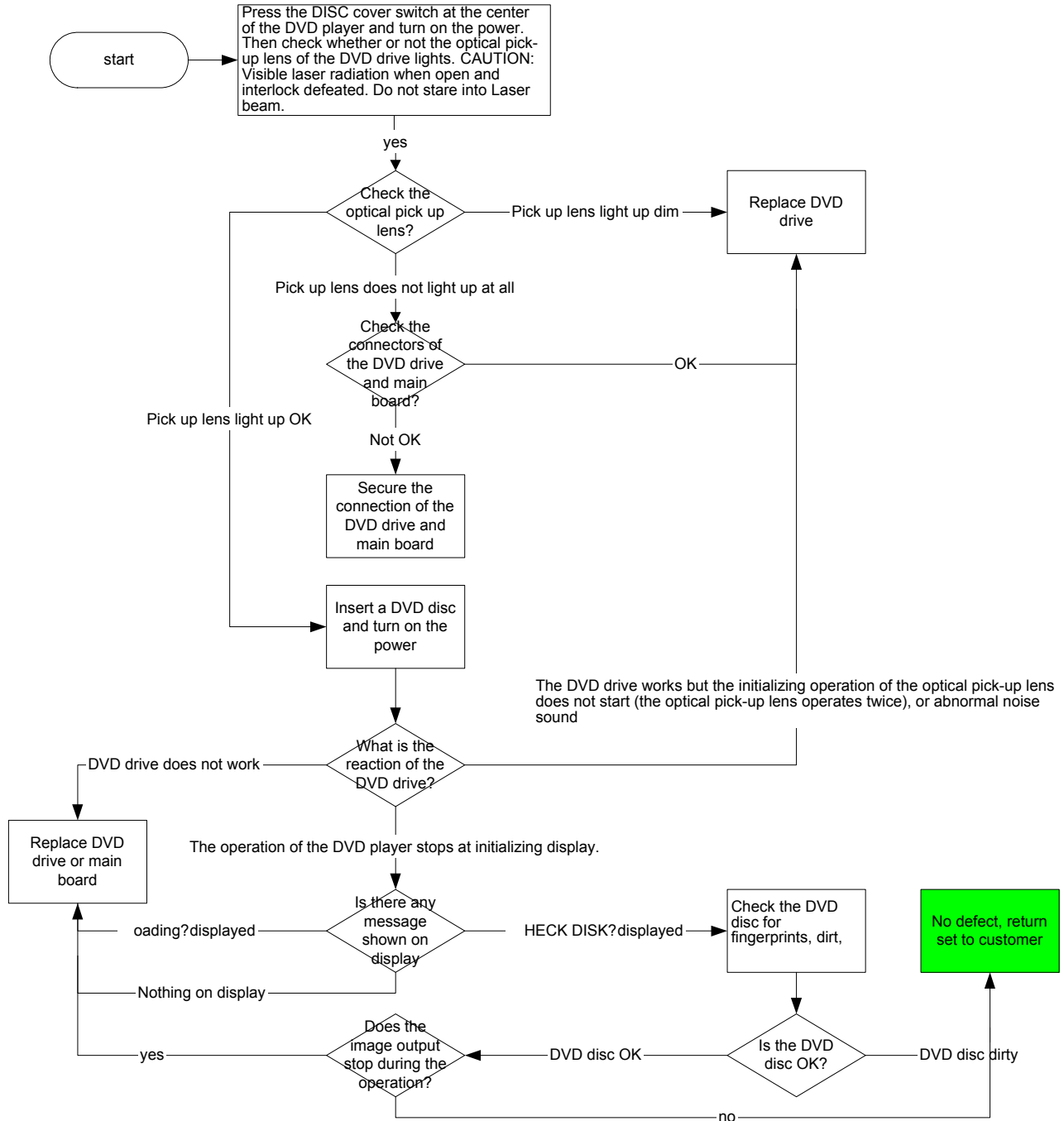

5.0 TROUBLESHOOTING & SERVICE TIPS

SYMPTOM: THE DVD DRIVE DOES NOT OPERATE WITH BATTERY

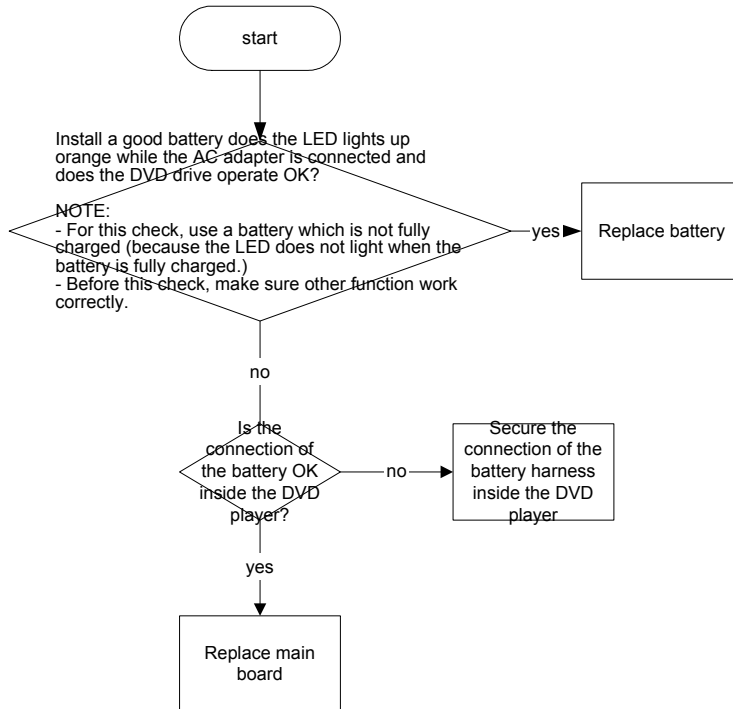

SYMPTOM: NO SOUND COMES FROM THE HEADPHONES

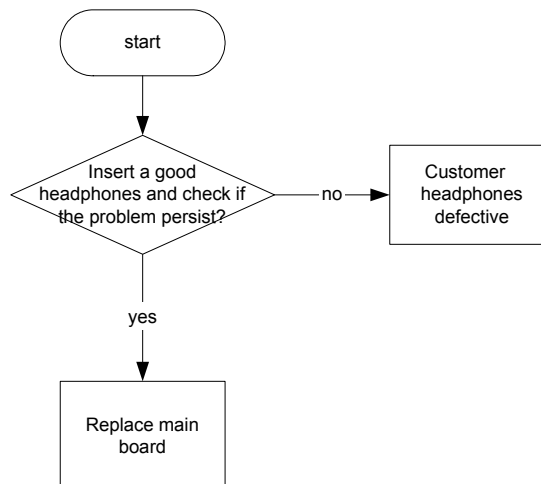

6.0 OVERALL BLOCK DIAGRAM

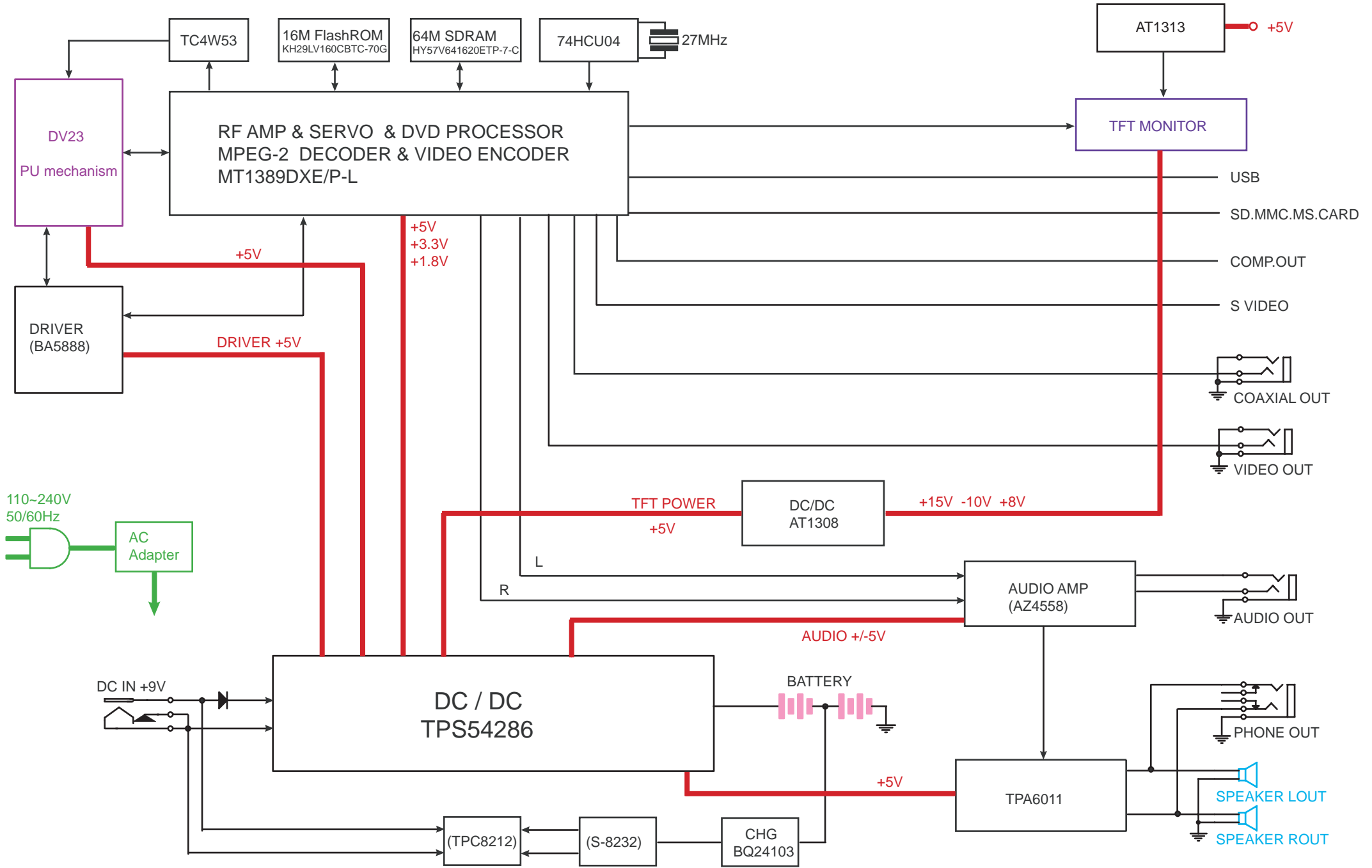

7.0 OVERALL WIRING DIAGRAM

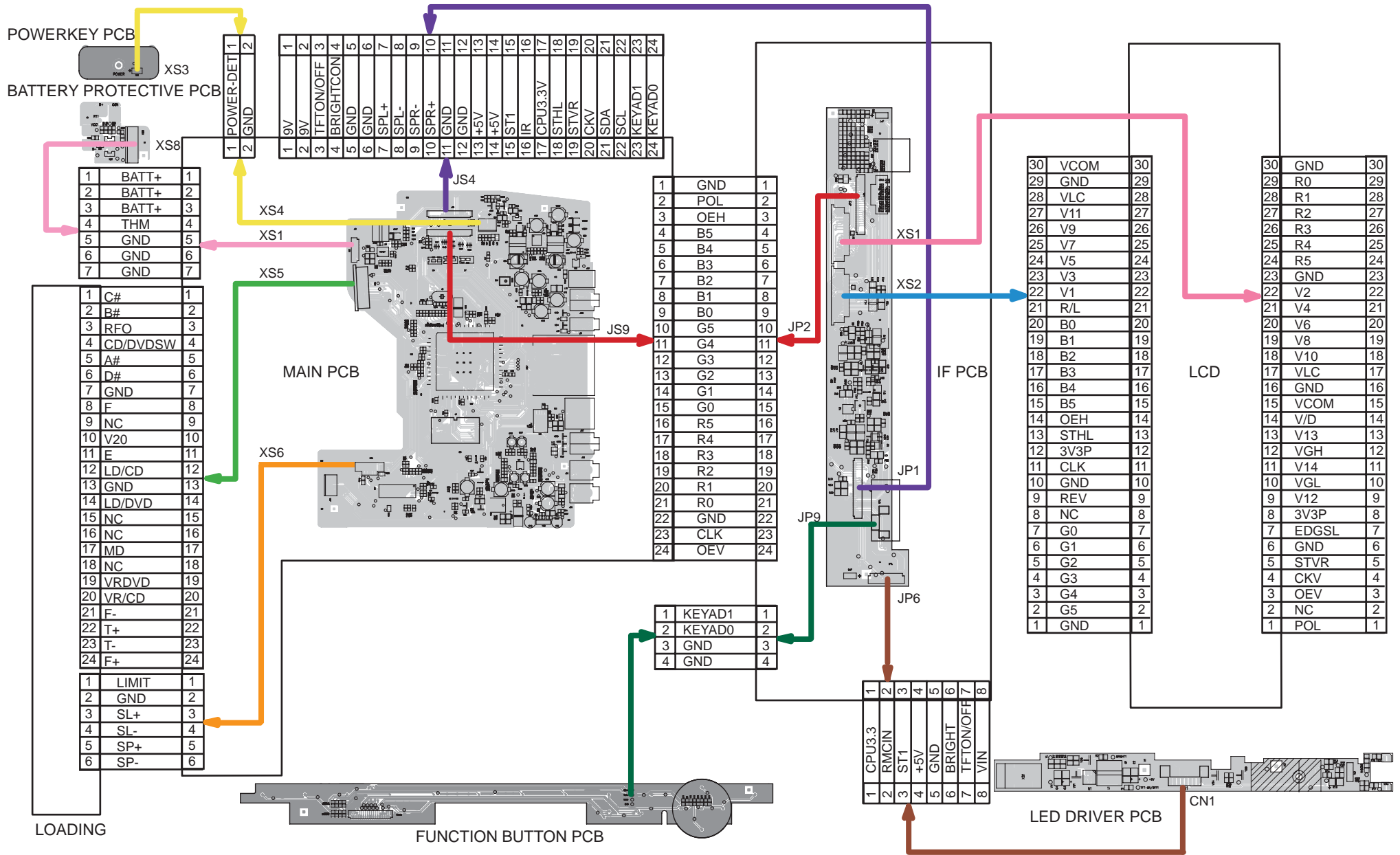

8.0 ELECTRICAL DIAGRAM - MAIN BOARD CIRCUIT DIAGRAM(MT1389P)

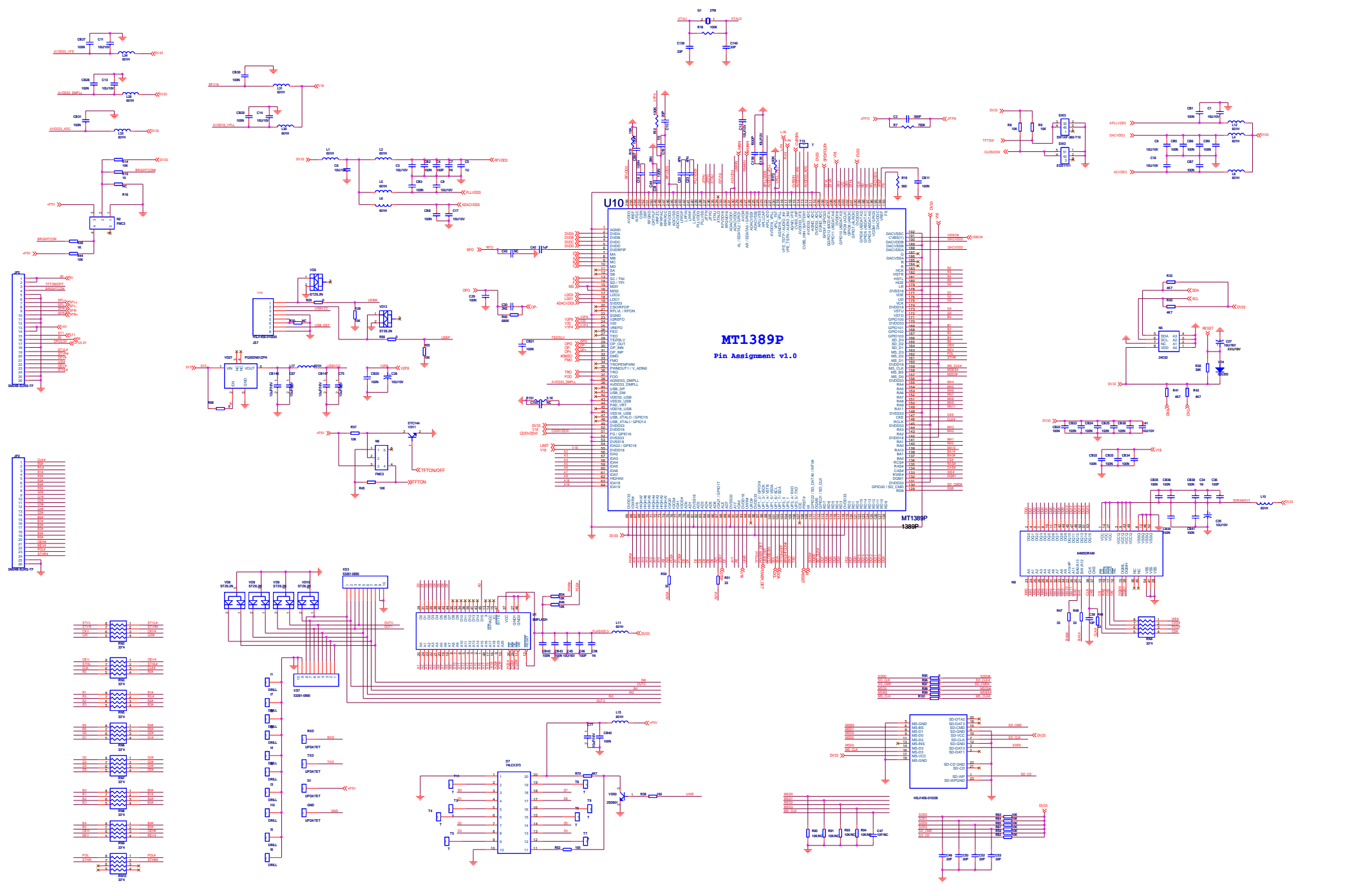

8.0 ELECTRICAL DIAGRAM - MAIN BOARD CIRCUIT DIAGRAM (AUDIO)

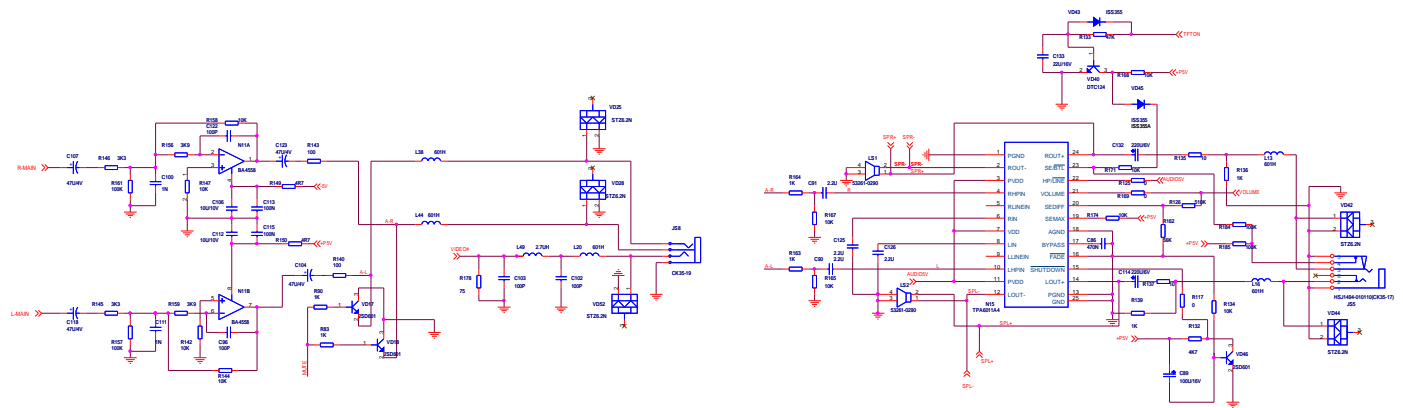

8.0 ELECTRICAL DIAGRAM - MAIN BOARD CIRCUIT DIAGRAM(DRIVER)

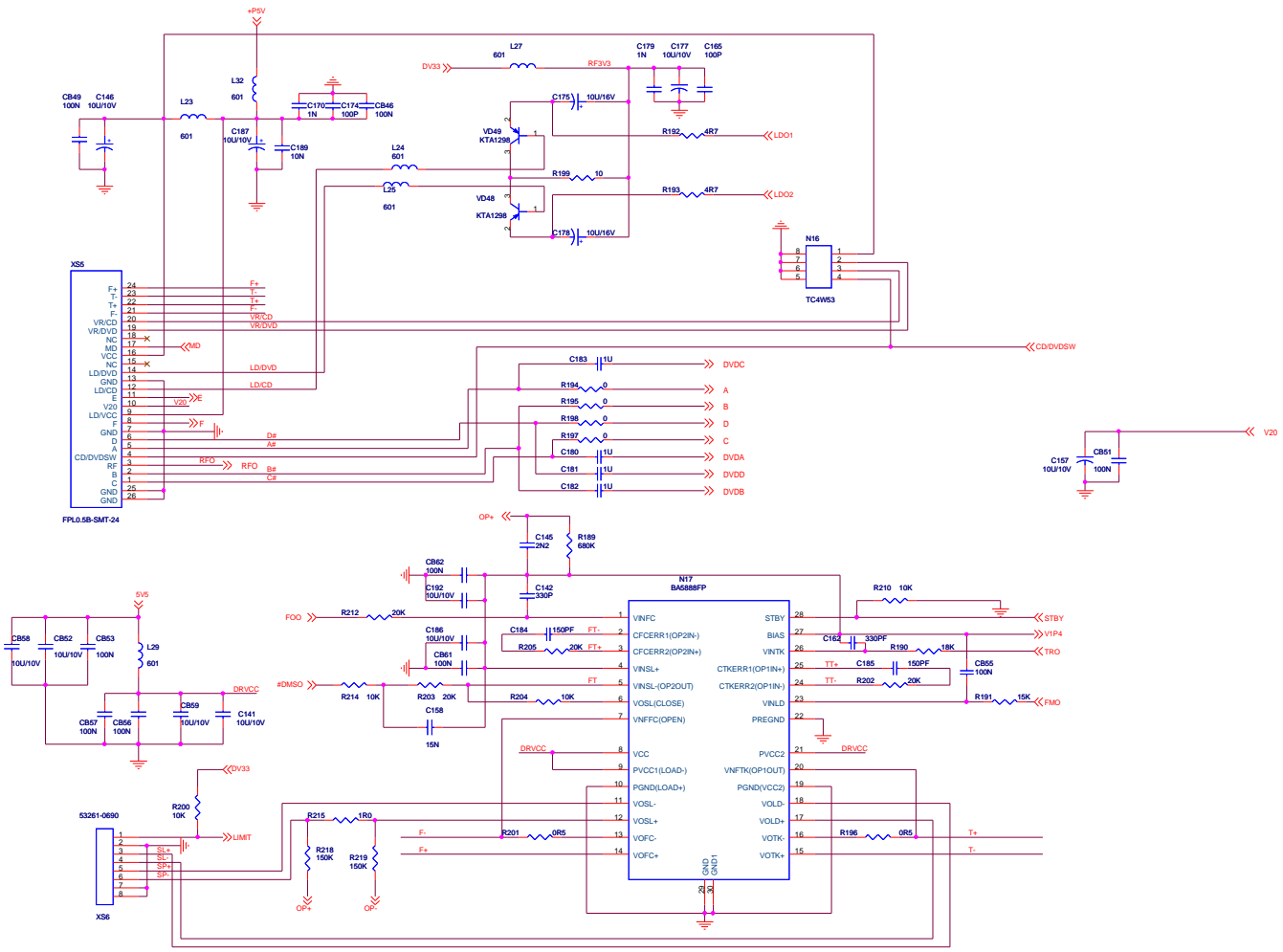

8.0 ELECTRICAL DIAGRAM - MAIN BOARD CIRCUIT DIAGRAM(POWER & CHARGE)

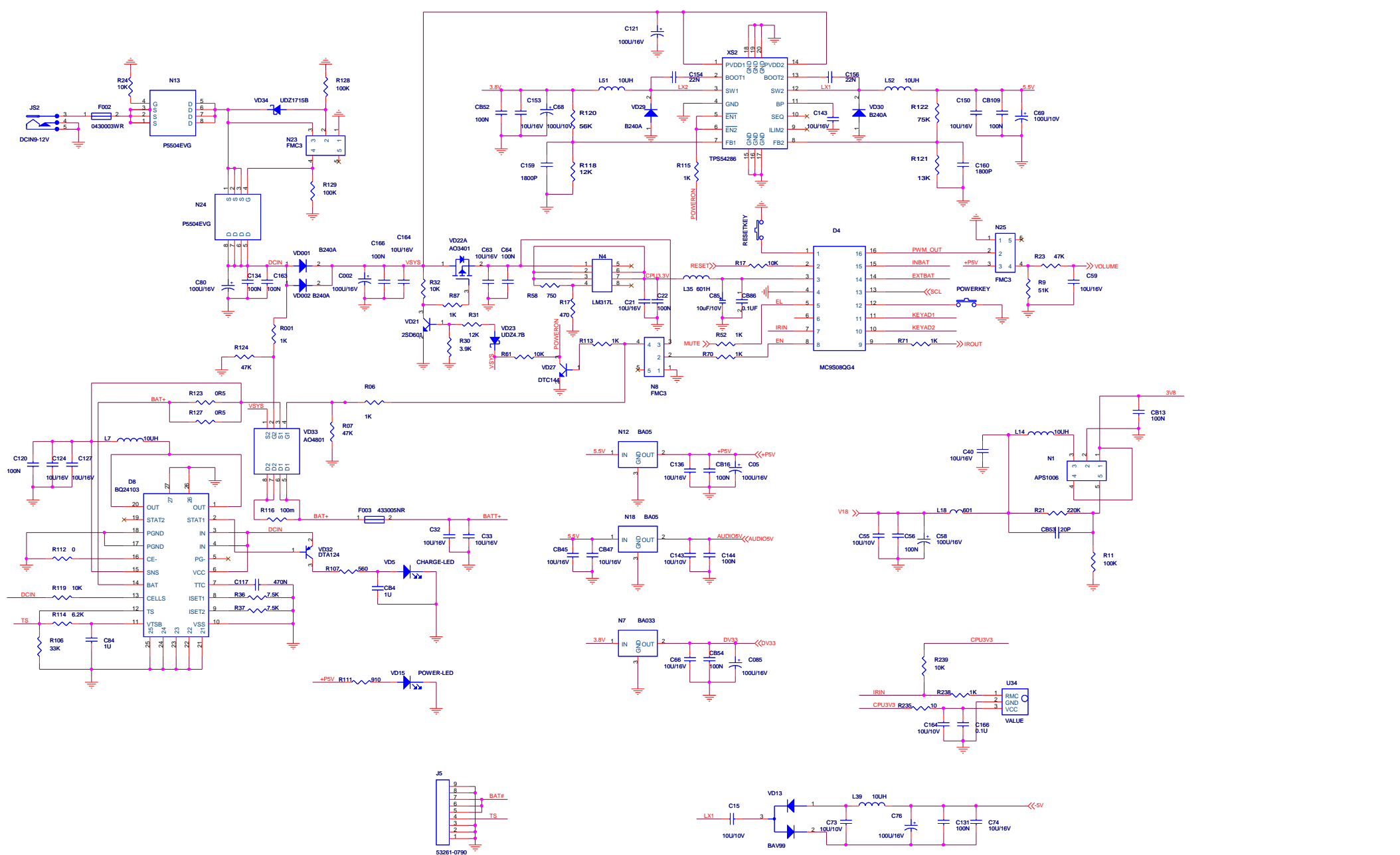

8.0 ELECTRICAL DIAGRAM - IF BOARD CIRCUIT DIAGRAM

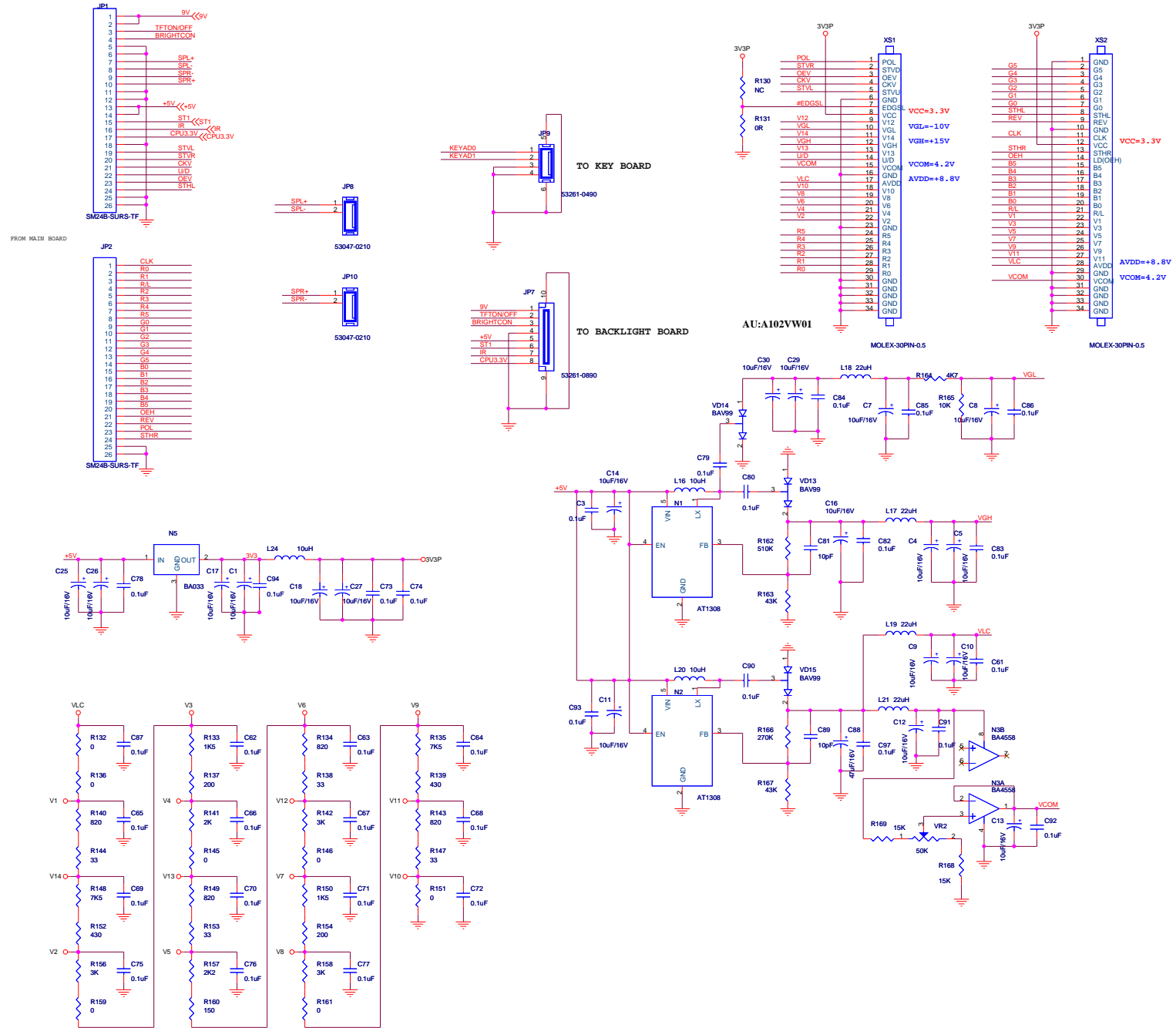

9.0 COMPONENT LAYOUT

PET1031M MAIN BOARD DIAGRAM (TOP)

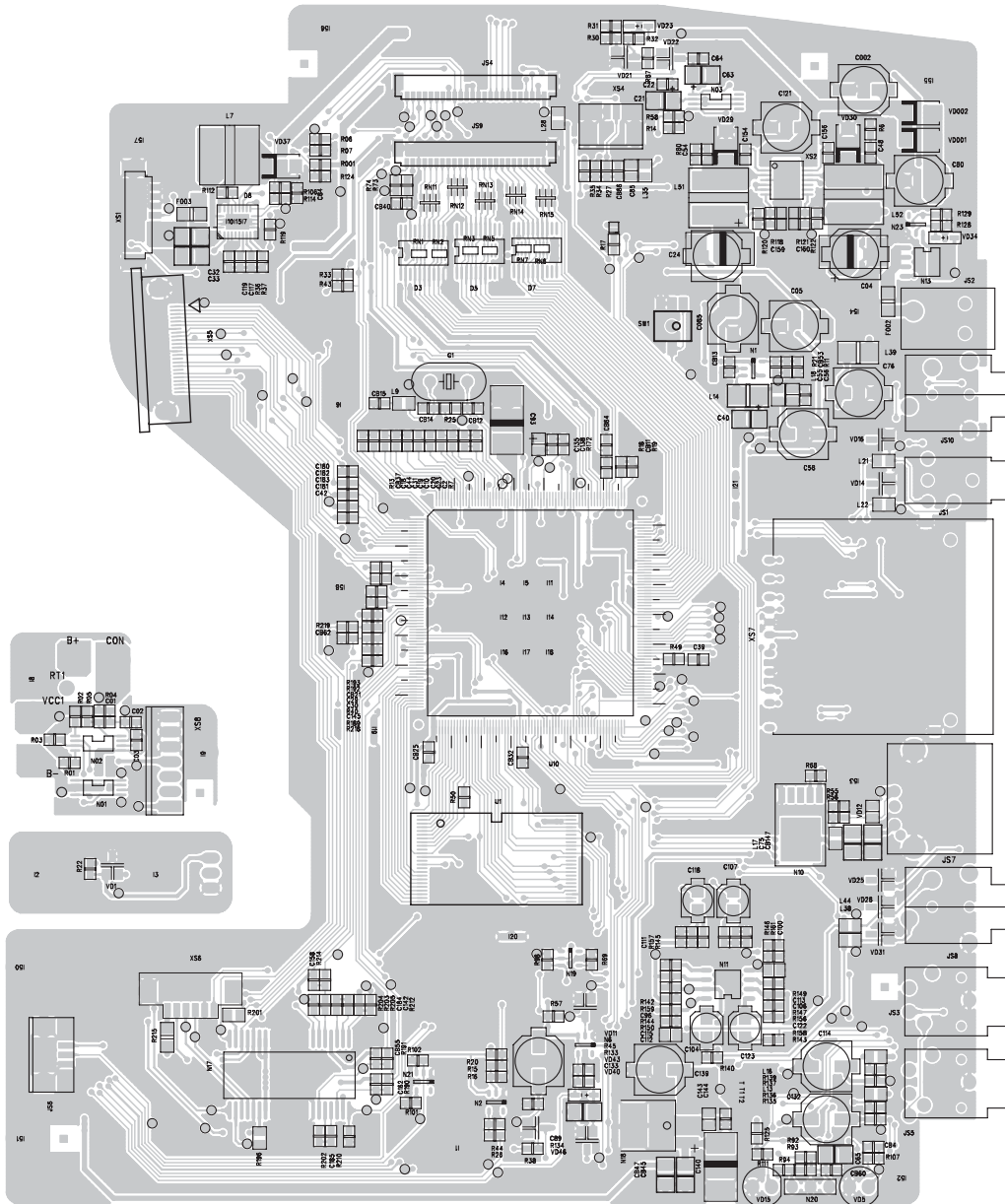

PET1031M MAIN BOARD DIAGRAM (BOTTOM)

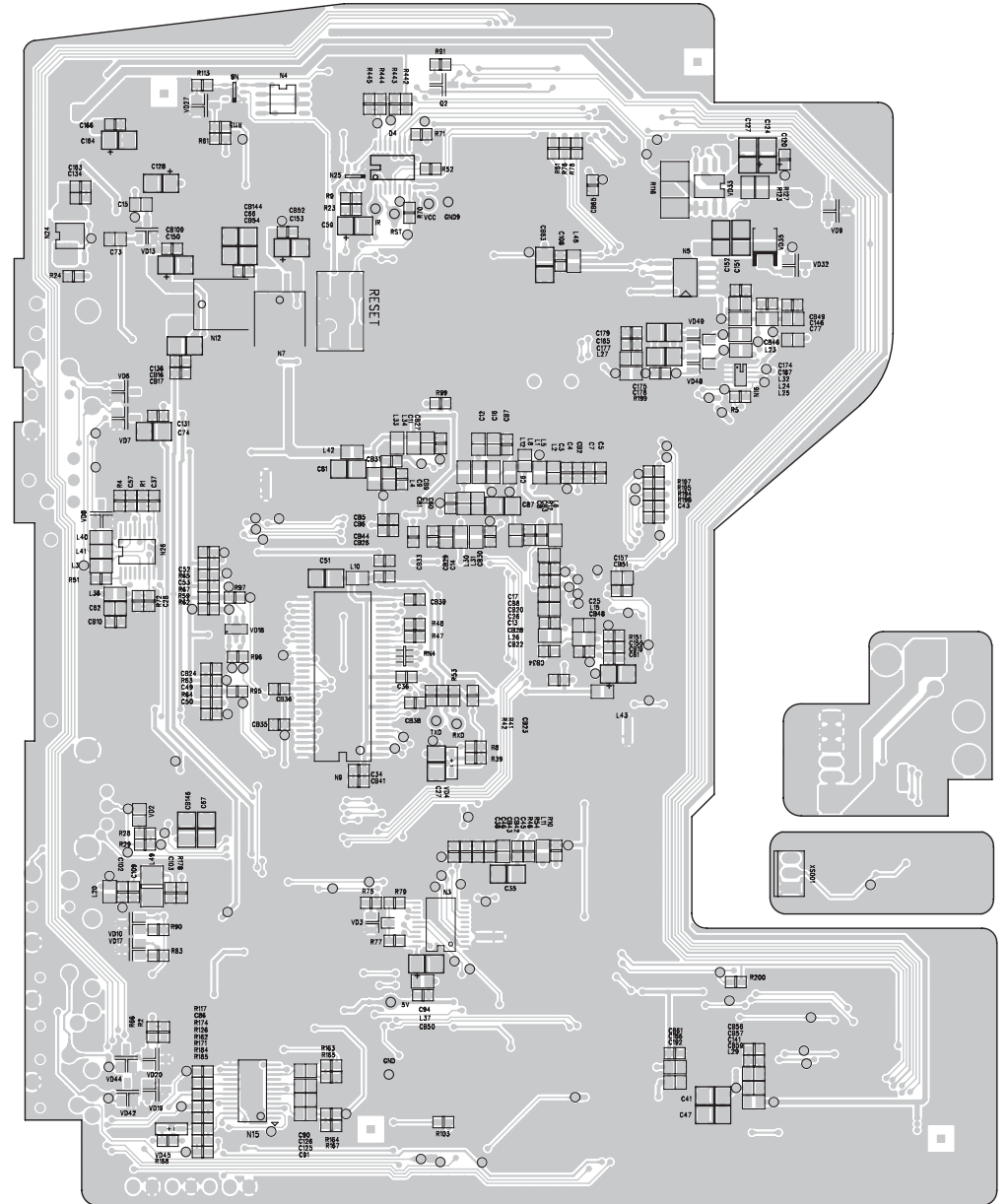

9.0 COMPONENT LAYOUT

PET1031 LED DRIVER BOARD DIAGRAM

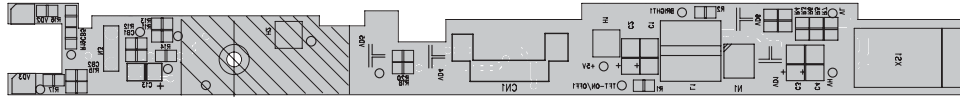

PET1031T IF BOARD DIAGRAM

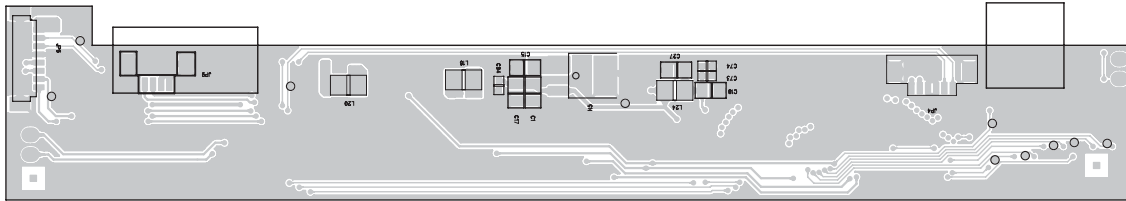
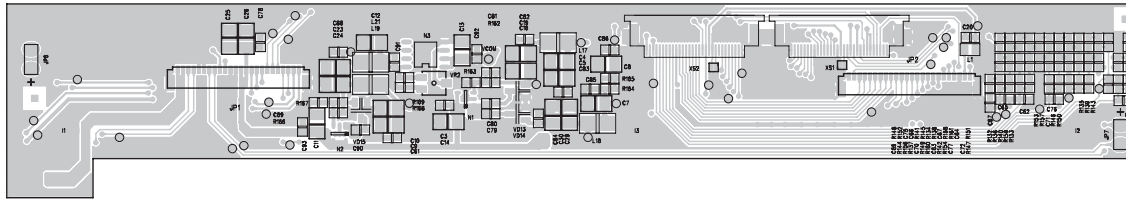



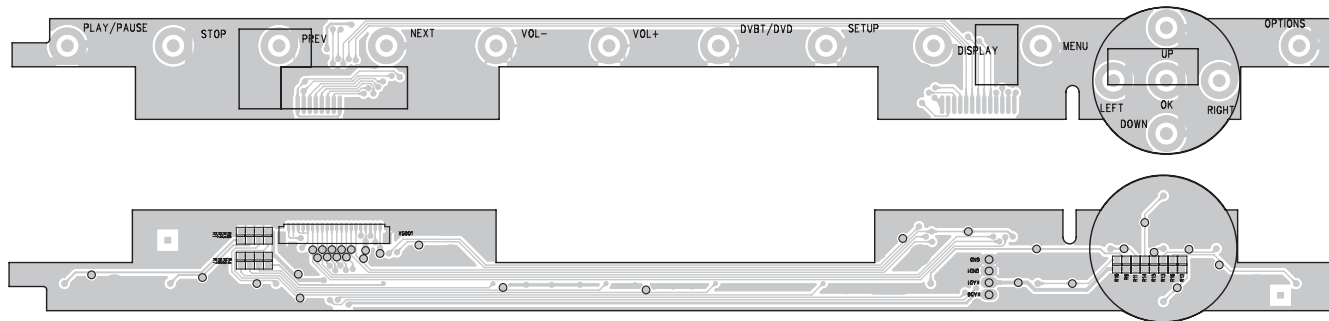



PET1030K FUNCTION BOARD DIAGRAM



10.0 SERVICE PART LIST

Electrical Part List:

CTN	Service 12NC	Service Description	Photo	Pos. No.
PET1031/12	996510009912	PET1031M MAIN PCB ASSY/12		100
PET1031/93	996510012441	PET1031M MAIN PCB ASSY/93		
PET1031/98	996510012440	PET1031M MAIN PCB ASSY/98		
PET1031	996510009913	PET1031T IF PCB ASSY		110
PET1031	996510009914	PET1031 LED DRIVER PCB ASSY		120
PET1031	996510003964	PET1030K FUNCTION PCB ASSY		130
PET1031	996510005764	PET1030 POWER KEY PCB ASSY		140
PET1031	996510018826	PET1030 BATTERY + PROCTIVE BOARD		150
PET1031	996510001274	24 PIN HARDNESS-180-PF		230





10.0 SERVICE PART LIST

Mechanical Part List:

CTN	Service 12NC	Service Description	Photo	Pos. No.
PET1031	996510009915	AT102TN03 TFT LCD		200
PET1031	996510004977	DV23FC LOADING ASS'Y		210
PET1031	994000002165	YD1635-2 SPEAKER		220
PET1031	996510003967	TOP COVER PET1030		300
PET1031	996510003968	DISPLAY FRAME PET1030		310
PET1031	996510003969	DOOR + MIDDLE CABINET PET1030		320
PET1031	996510009919	BASE COVER PET1031		330

10.0 SERVICE PART LIST

Mechanical Part List:

CTN	Service 12NC	Service Description	Photo	Pos. No.
PET1031	996510006727	BASE COVER ADORN DISCRETENESS		340
PET1031	996510006728	PET1030 SPEAKER SKILL		350
PET1031	996510003972	ADJUST HINGE PET1030		360
PET1031	996510003973	LENS REMOTE SENSOR PET1030		370

10.0 SERVICE PART LIST

Accessories Part List:

CTN	Service 12NC	Service Description	Photo	Pos. No.
PET1031/12 PET1031/98	996510009918	ADPV26A AC POWER ADAPTOR/00		ADAPTOR
PET1031/93	996500042048	ADPV26A AC POWER ADAPTOR/93		
PET1031	996510001124	CAR CIGARETTE ADAPTER		CARADAPTOR
PET1031	994000001912	AV CABLE		AVCABLE
PET1031	994000002585	CHROMATISM CABLE		CCABLE
PET1031	994000002586	DVD960 S- VIDEO CABLE		SCABLE
PET1031	996510001287	RC-AY5507 REMOTE CONTROL		RC
PET1031	996510001130	CAR MOUNT AY4246		CARMOUNT
PET1031	996510010516	TRAVEL BAG		BAG

11.0 REVISION LIST

Version 1.0 (3141 785 32250)

- Initial release PET1031/12

Version 1.1 (3141 785 32251)

- Section 10 - Add spare part for PET1031/93, PET1031/98

Version 1.2 (3141 785 32252)

- Section 8 – Update electrical diagram

Version 1.3 (3141 785 32253)

- Section 8 – Remove spare part 996510009916 and 996510009917, as not for service correction

Version 1.4 (3141 785 32254)

- Section 8 – Remove spare part 996510006526 and 996510003961, replace by 996510018826